



安博尔机械
ANBER MACHINE



微信公众号
Scan with wechat!



官方网站
Our website



WUXI ANBER MACHINE CO., LTD. | 无锡安博尔机械有限公司

EXPANDED METAL MESH MACHINE

钢板网冲剪机



无锡安博尔机械有限公司
WUXI ANBER MACHINE CO., LTD.

Address: NO. 525, Jindong Road, Jinxi
Town, Kunshan, China.
Tel: (+86)-510-88239310/88239309
Fax: (+86)-510-88237950
Email: sales@anber-inc.com
Web: www.china-anbermachine.com

地址: 江苏省苏州市昆山锦溪镇锦东路525号
电话: 0510-88239310/88239309
传真: 0510-88237950
邮箱: sales@anber-inc.com
网址: www.anbermachine.com

www.anbermachine.com
Email: sales@anber-inc.com

Company Profile

Wuxi Anber Machine Co., Ltd. is a professional manufacturer and trader specialized in the research, development and production of wire mesh machine. Our factory is located in Kunshan, Jiangsu with convenient transportation access. All of our products comply with international quality standards and are greatly appreciated in a variety of different markets throughout the world.

Our mainly products include:

Expanded metal mesh machine: light type expanded metal mesh machine, middle type expanded metal machine, heavy duty expanded metal machine, expanded metal mesh leveling, slitting and cutting line, expanded metal mesh slitting line, copper battery mesh production line and related accessories including de-coiler, expanded mesh flattening machine, expanded mesh leveling machine, expanded metal mesh leveling, slitting and cutting machine and high quality mold.

Building mesh machine: rib lath machine, hi-rib lath machine, plaster mesh machine, angle bead machine, plaster stop bead machine, brickwork reinforcing machine, brickwork mesh/diamond metal lath machine, architrave bead machine, movement bead machine.

Welded wire mesh machine: full automatic mesh welding machine, mechanical mesh welded machine, CNC mesh welder, pneumatic welded mesh machine, fence welded machine, welded mesh machine for construction, reinforcement mesh welding production line, mesh welding line, truss girder welding line, steel grating welding machine.

Wire drawing machine: pulley type wire drawing machine, straight line wire drawing machine, water type wire drawing machine, vertical type wire drawing machine, rolling cassette and accessories including wire pay off, wire straightening and cutting machine, wire take up, wire descaling machine, butt welding machine, wire pointing machine, wire annealing furnace, etc. Other wire mesh machinery: gabion mesh machine, chain link fence machine, steel bar stirrup bender, razor barbed wire machine, barbed wire machine, hexagonal wire netting machine, wire PVC coating line, PVC powder painting line, PE powder coating line, etc.

Our vision is to maintain and improve our leading position as a contractor whose reputation is built on the ability to completely satisfy customers by providing high quality services. As specialists in their respective fields, our teams of professionals are dedicated to a standard of excellence for quality and performance, through continuous development, which will set standards in our industry.

公司简介

无锡安博尔机械有限公司是一家设计、制造、销售丝网设备及金属板材加工设备的专业厂家。我公司地处江苏昆山，交通便利。我公司所有产品采用国际质量标准，产品远销海外，享誉海内外众多市场。

公司主要产品有：

钢板网冲剪机：各种型号重、中、小型钢板网机及其辅机开料架、压平机、整平机、整平纵切横切一体机，钢板网分条线等，并配套提供优质模具。

建筑墙体网机：批汤砖带一体机，砖带网机，批汤网机，有筋扩张网设备，快易收口网机，护角网机，门楣网机，伸缩缝设备。

焊网机：全自动数控钢筋网焊机、358/3510防攀爬网（高安全防护网）焊机、高速公路及铁路数控护栏网排焊机、舒乐板网排焊机、煤矿支护网焊机、3D板焊接机及钢筋调直切断机、折网机、剪网机、除磷机等。

全自动钢筋桁架设备：2D桁架焊接机，平面桁架焊接设备，3D立体钢筋桁架焊接设备等。拉丝机：直进式拉丝机、滑轮式拉丝机、水箱式拉丝机、倒立式拉丝机及辅机产品，包含各种放线架、工字轮放线机、工字轮收线机、象鼻子卸线机、倒立式收线机、剥壳机、井式退火炉、连续生产箱式退火炉、轧尖机、对焊机、前处理生产线等。提供气保焊丝生产线，药芯焊丝生产线，并可提供拉丝，热处理镀锌“一条龙”工程的设计和制造。

冷轧带肋钢筋生产线（精密轧机）及其辅助设备。

石笼网机：又称格宾网机，六角网机，同时我们配套制造整经机，收网机，绕簧机，打轴机（筒子机），剪网机，调直机（校直机），平网机，液压打包机等辅助设备。

其他丝网设备：勾花网机，刀片刺绳机，铁丝刺绳机，钢格板焊接机等。

浸塑设备：各种燃煤，燃气，燃油，电热浸塑生产线设备，包含卷网浸塑设备、片隔离栅（片网）浸塑设备、防腐钢管浸塑设备、护栏板浸塑设备等自动、半自动、手动的高中低档浸塑生产线设备。

公司在管理中采用ISO9001质量管理体系，推进企业标准化管理，保证了产品质量不断提升。公司以“以创新求发展 以质量求生存 以客户的满意为我们的最终目标”为营销理念，用过硬的质量、良好的信誉、优质的服务、合理的价格，不断拓展市场。目前公司销售网络已遍及全国各地，并已出口至阿尔及利亚、南非、亚美尼亚、塞尔维亚、玻利维亚、委内瑞拉、沙特、摩洛哥、肯尼亚、苏丹、也门、保加利亚、印度、澳大利亚、俄罗斯、美国、阿根廷等20多个国家和地区。

我公司愿与您精诚合作，共创辉煌的明天。竭诚欢迎海内外各界新老朋友前来洽谈，并随时恭候您的惠顾光临。

目录 CATALOGUE

钢板网机描述	02	Description Of Expanded Mesh Machine
钢板网机选型表	03	Selection Of Expanded Mesh Machine
钢板网分条生产线	04	Expanded Mesh Slitting Production Line
ABE-GS25-1250(25T)高速钢板网机	05	ABE-GS25-1250(25t) High Speed Expanded Mesh Machine
ABE-GS40-1250(40T)高速钢板网机	06	ABE-GS40-1250(40t) High Speed Expanded Mesh Machine
ABE-GS60-1250(60T)高速钢板网机	07	ABE-GS60-1250(60t) High Speed Expanded Mesh Machine
ABE-1.0-600(6.3T)钢板网机	08	ABE-1.0-600(6.3t) Expanded Mesh Machine
ABE-1.0-1000(16T)钢板网机	09	ABE-1.0-1000(16t) Expanded Mesh Machine
ABE-1.5-1250(25T)钢板网机	10	ABE-1.5-1250(25t) Expanded Mesh Machine
ABE-4.0-1300(60T)钢板网机	11	ABE-4.0-1300(60t) Expanded Mesh Machine
ABE-2.5-1500(40T)钢板网机	12	ABE-2.5-2500(40t) Expanded Mesh Machine
ABE-6.0-2000(100T)钢板网机(材料摆动型)	13	ABE-6.0-2000(100t) Expanded Mesh Machine(Material Moving Type)
ABE-6.0-2000(100T)钢板网机(模具摆动型)	14	ABE-6.0-2000(100t) Expanded Mesh Machine(Mold Moving Type)
ABE-6.0-2500(100T)钢板网机	16	ABE-6.0-2500(100t) Expanded Mesh Machine
ABE-8.0-2500(260T)钢板网机	17	ABE-8.0-2500(260t) Expanded Mesh Machine
铜极网生产线	18	Copper Battery Mesh Expanding Line
辅助设备	19	Accessory Machine
钢板网示意图	24	Legend Of Expanded Metal
钢板网产品	25	Typical Expanded Metal Mesh
钢板网选型表	26	Chart Of expanded Metal Mesh
钢板网生产线询盘需求表	27	Selection Guidance For Expanded Metal Mesh Production Line



高新技术企业证书
High-tech enterprise certificate



中国产学研一等奖证书
chinese industry-academy-research award



营业执照 / Business certificate



CE证书 / CE certificate



ISO证书 / ISO certificate



护角网机专利
Patent of angle bead machine



批荡砖带一体机专利
Patent of metal lath and brickwork mesh machine



砖带网机专利
Patent of brickwork mesh machine

ENTERPRISE HONOR
企业荣誉 >>

钢板网生产线 / Expanded Metal Mesh Production Line

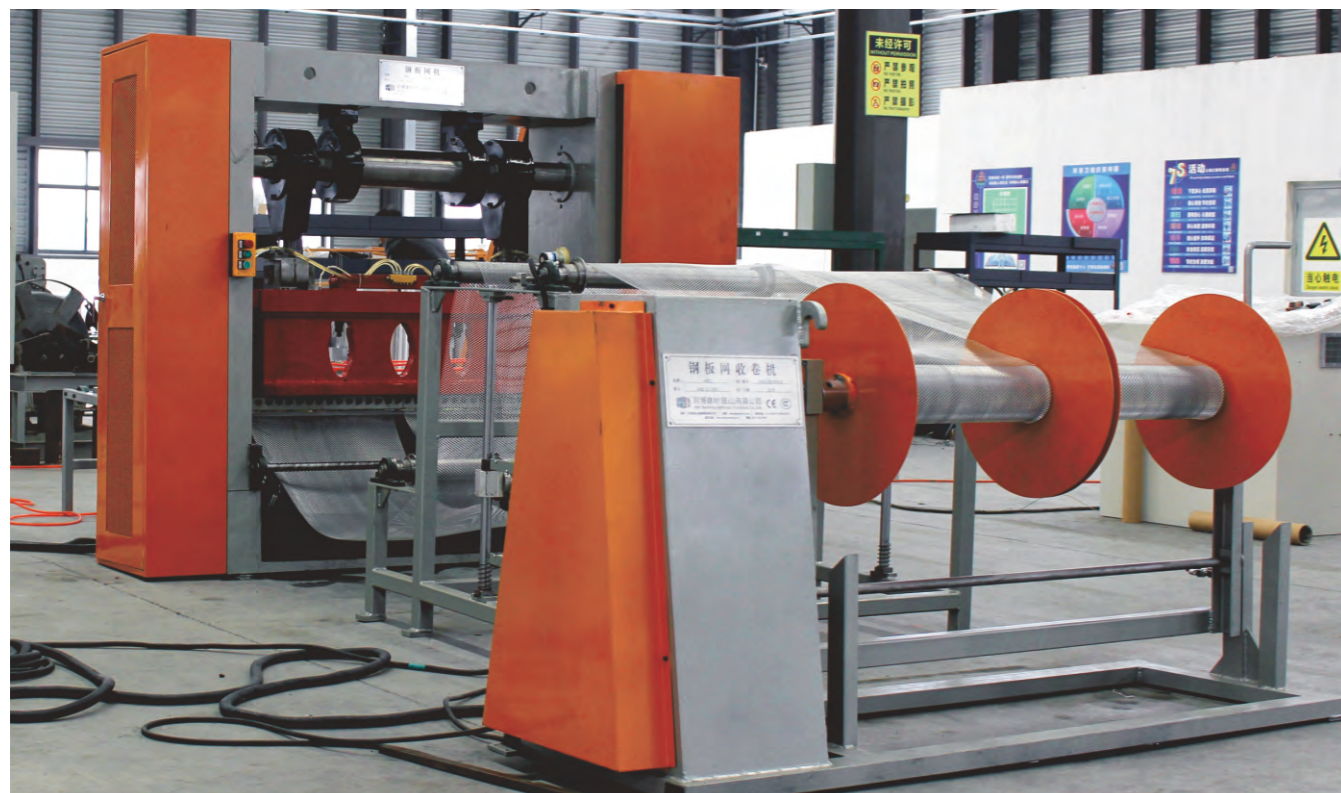

钢板网机描述 / Description of Expanded Mesh Machine

钢板网冲剪机又称钢板网机是用于将不同材质的材料包含：冷/热轧板、镀锌板、不锈钢板、铝板、铜板、钛板等按基本参数规定的厚度、宽度冲裁成菱形、六角形、半圆形、异形等多种网格形状的专用设备，所冲钢板网广泛用于建筑、五金、门窗、机床、电子工业品、家电产品的防护及装饰等，尤其是经过表面处理的钢板网广泛用于装潢及家庭用品。

Description:

The expanded metal mesh machine is used produce the expanded metal mesh, also is called expanded metal lath, can be used in construction, hardware, door and windows and lathes. Some products with surfacing processed can be wildy used in decoration of the building or house. The machine is in high speed with satisfied expanded mesh. The shearing force of the expander is related to the thickness of the materials as well as the LWD. Considering the same thickness of the raw materials, the shearing force will increase with the decreased LWD.

What is expanded metal mesh?

Expanded Metal Mesh is traditionally seen as a metal material with diamond shaped holes. Expanded Metal is produced by an expanding machine, which uses a pressured slitting and stretching process to transform solid metal sheets and coils into expanded mesh. Most types of metal including precious and specially produced metals can be expanded. Type of expanded mesh includes micro mesh, rhomboidal mesh, round mesh, square mesh, hexagonal mesh, heavy mesh which will be used for automotive industry, energy, household appliances, chemical industry, oil industry, solar industry, etc.

Expanded metal mesh production process:

1. Sheets or coils or metal are fed into the expanding machine. A little metal can create a lot of mesh, adding value and saving resources and money.
2. Each machine is fitted with a unique "Knife", dedicated to a particular pattern. New patterns and knives can be created in-house for specific applications.
3. The machines are then programmed or manually controlled to ensure the metal is expanded to the exact specification. Rigorous quality checks are carried out to ensure product consistency throughout the expanding process.
4. Using the unique shearing and stretching process means very little waste is created. the metal is sheared and then stretched in a single process creating the apertures and therefore expanding the metal. The mesh is then either cut into sheets or wound onto coils ready for shipping or further processing.

钢板网机选型表 / Selection of Expanded Mesh Machine

钢板网冲剪机包含高速钢板网机, 轻型钢板网机(6.3T, 16T, 25T); 中型钢板网机(40T, 60T); 重型钢板网机(63T, 100T, 160T, 260T)。
Our expanded metal machine has several types as high speed expanded metal machine, light type expanded metal machine(6.3T, 16T, 25T), middle type expanded metal machine(40T, 60T) and heavy duty expanded metal machine(63T, 100T, 160T, 260T).

Model	型号	Unit	ABE-GS25-1250	ABE-GS40-1250	ABE-GS60-1250	ABE-1.0-600	ABE-1.0-1000	ABE-1.5-1250	ABE-2.5-1500
Normal pressure	公称压力	T	25	40	60	6.3	16	25	40
Thickness of material	冲剪板料厚度	mm	≤1.5	≤1.5	≤1.5	≤1.0	≤1.0	≤1.5	≤2.5
Max. material width	板料最大宽度	mm	1250	1250	1250	600	1000	1250	1500
Expanding speed	冲剪次数	Strokes /min	480	500	500	260	260	300	100-150
Length ways feeding	纵向送料距离	mm	0-5.0	0-5.0	0-5.0	0-0.3	0-0.3	0-0.3	0-3.5
Max. LWD	最大长截距	mm	60	60	60	20	40	40	80
Motor power	电机功率	KW	11	11	15	4.0	5.5	7.5	11
Machine weight	整机重量	T	4.3	5	8	1.2	2.5	4.7	6
Overall size(L*W*H)	外型尺寸 长*宽*高	m	2.2×1.4×2.1	2.2×1.4×2.2	2.4×1.0×2.7	1.3×0.6×1.4	1.7×1.1×1.8	2.5×1.4×2.15	2.87×0.9×2.14
Material type	进料方式		卷进料 Coil	卷进料 Coil	卷进料 Coil	卷进料 Coil	卷进料 Coil	卷进料 Coil	卷进料 Coil

Model	型号	Unit	ABE-4.0-1300	ABE-6.0-2000	ABE-6.0-2000	ABE-6.0-2500	ABE-6.0-3000	ABE-8.0-2500	ABE-8.0-3000
Normal pressure	公称压力	T	60	100	100	100	160	260	260
Thickness of material	冲剪板料厚度	mm	≤4.0	≤6.0	≤6.0	≤6.0	≤6.0	≤8.0	≤8.0
Max. material width	板料最大宽度	mm	1300	2000	2000	2500	3000	2500	3000
Expanding speed	冲剪次数	Strokes /min	85-100	80	50-60	50-60	50-60	35-40	35-40
Length ways feeding	纵向送料距离	mm	0-4.0	0-20	0-7.0	0-7.0	0-10	0-20	0-20
Max. LWD	最大长截距	mm	70	150	150	150	200	200	200
Motor power	电机功率	KW	11	30	18.5	22	37	55	55
Machine weight	整机重量	T	7	14	12	13	26	28	32
Overall size(L*W*H)	外型尺寸 长*宽*高	m	2.7×1.5×2.2	4.15×1.9×2.57	3.5×1.2×3.31	4.0×1.1×2.4	5.1×4.2×2.52	4.7×2.4×3.05	5.1×4.2×2.52
Material type	进料方式		卷进料 Coil	卷进料/片进料 Coil/sheet	片进料 Sheet	片进料 Sheet	片进料 Sheet	片进料 Sheet	片进料 Sheet



钢板网分条生产线 / Expanded Mesh Slitting Production Line

菱形网分条线流程

本生产线首先利用开卷机将镀锌钢板或不锈钢薄板卷料主动放出, 卷料通过冲网总机上的送料机构进入冲网环节, 冲网机通过电机皮带传动将动力传递给曲轴, 进而带动模具作上下高速冲剪运动, 将薄钢板冲剪成型, 进而由后级整平分条机拉伸成所要求的产品尺寸。最后自动收卷机开始收卷成型的产品。

主要技术参数

开料架
内径: Φ40mm—Φ500mm 可调
承重: 2-3吨
电机: 功率: 2.2KW (380V-50HZ)
钢板网机
冲网速度: 180-300次/分钟
模具驱动: V带传动
电机功率: 4KW, 380V, 50HZ
模具: 材质: Cr12MO1V1, 硬度: HRC58-62

整平分条机
电机功率: 2.2KW, 380V, 50HZ
驱动型式: 链传动
自动收卷机
电机: 1.5KW, 380V, 50HZ
收卷宽度: 200-400mm
收卷机数量: 3台

Main technical parameters:

De-coiler
I.D.: Φ40mm—Φ500mm, adjustable
Loading weight: 2-3 tons
Motor power: 2.2KW

Expanded metal mesh machine
Speed: 180-300 stroke per min;
Drive type: V belt drive;
Motor power: 4KW, 380V 50HZ;
Mould: Cr12MO1V1, hardness: HRC58-62

Leveling and slitting machine
Motor: 2.2KW, 380V 50HZ
Drive type: by chain

Auto re-coiler
Motor: 1.5KW, 380V 50HZ
Width of recoiling: 200-400mm, adjustable
Quantity of re-coiler: 3 pieces



ABE-GS25-1250 (25T)高速钢板网机/ High Speed Expanded Mesh Machine

Main Technical Parameters

Model: ABE-GS25-1250
 Normal pressure: 25T
 Expanding speed: ≤ 480 Strokes/min
 Length ways feeding: 5mm
 Max. LWD: 60mm
 Thickness of material: 1.5mm
 Max. material width: 1250mm
 Motor power: 11KW
 Servo motor Power: 2KW
 Working Air Pressure: 0.4-0.6MPA
 Overall size(L*W*H): 2210*1440*2120mm
 Machine weight: about 4.3T

主要技术参数

型号: ABE-GS25-1250
 冲力: 25T
 冲网速度: ≤ 480 次每分
 送料距离: 5mm
 最大长截距: 60mm
 最大原材料厚度: 1.5mm
 最大原材料宽度: 1250mm
 主电机功率: 11KW
 伺服送料电机功率: 2KW
 工作气压: 0.4-0.6MPA
 外形尺寸(长*宽*高) 2210*1440*2120mm
 机器重量: 约4.3T

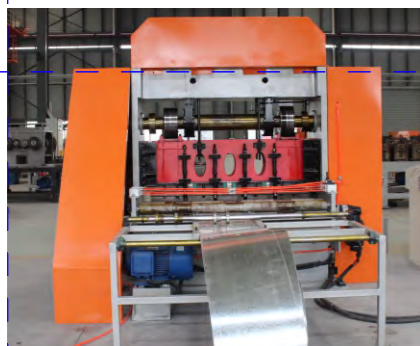

ABE-GS40-1250 (40T)高速钢板网机/ High Speed Expanded Mesh Machine

描述:

钢板网生产线是用于生产特定长度宽度, 具有重量轻、强度高的特点的钢板网机器, 所生产产品广泛用于建筑、五金、门窗、防护网等行业。

Description:

Expanded Metal Mesh is traditionally seen as a metal material with diamond shaped holes. Expanded Metal is produced by an expanded metal machine, which uses a pressured slitting and stretching process to transform solid metal sheets and coils into expanded mesh. Most types of metal, including precious and specially produced metals, can be expanded.

Main Technical Parameters

型号: ABE-GS40-1250
 公称压力: 400KN
 冲剪板料厚度: ≤ 1.50 mm冷态钢板
 冲剪板料宽度: ≤ 1250 mm
 滑块行程次数: ≤ 500 次/min
 滑块行程: 22mm
 压料力: 1.5×4 KN
 连杆调节距离: 10mm
 纵向送料距离: 0~5mm
 横向摆动距离: 0~20mm
 电机: Y2-160M-11/4, 11kw, 1460RPM
 伺服送料电机: 2.0kw/2000 rpm, 速比i10
 工作电压: 三相, AC380V/50Hz
 外形尺寸(长*宽*高): 2120*2370*2200mm
 重量: 5T

主要技术参数

Model: ABE-GS40-1250
 Punching force(Nominal pressure): 400KN
 Material thickness: ≤ 1.50 mm cold steel
 Width: ≤ 1250 mm
 Punching speed: ≤ 500 strokes/min
 Slider trolley: 22mm
 Pressing force: 1.5×4 KN
 Feeding distance: 10mm
 Line feeding distance: 0~5mm
 Mold driven distance: 0~20mm
 Motor: Y2-160M-11/4, 11kw, 1460RPM
 Feeding motor: 2.0kw/2000 rpm, speed ratio i10
 Voltage: 3 phase, AC380V/50Hz
 Size: 2120*2370*2200mm
 Weight: 5T



ABE-GS60-1250 (60T)高速钢板网机/High Speed Expanded Mesh Machine

General description:
Anber high speed expanded mesh machine, it is high speed and CE certificated.
Application: Industry and civil architecture, road, railway.
Main parameter of the equipment:
Max. Working speed:

500strokes/minute
Punch force: 60T
Servo motor Power: 1.5KW, rotate speed: 2000r/min
Motor Power: 15KW, rotate speed: 1440r/min
Equipment size: 2440×1000×2700mm
Weight: 8T

描述:
钢板网是采用热轧板冲压成型的一种建筑产品,具有重量轻、强度高的特点。主要用于建筑产品或公路、铁路的防护设备。
应用领域: 工业民用建筑、公路、铁路。
主要参数:
冲网速度: 500次/分
冲床冲力: 60T
伺服电机功率: 1.5KW, 转速: 2000r/min
电机功率: 15kW, 转速: 1440r/min
设备尺寸: 2440×1000×2700mm
重量: 8T



ABE-1.0-600 (6.3T)钢板网机 / Expanded Mesh Machine

Description of Expanded Metal Machine

This expanded metal mesh machine can process cold-rolled steel, aluminum material to expanded mesh with hexagonal, diamond, round, etc. which are used for building, hardware, machine tool, electric industrial, protective and decoration of Material strength is under 450N/mm², material with elongation over 25%. Expanded process is finished by crankshaft connecting rod system, moved by cam, feed by stepping motor, the feeding distance can be easily adjusted. This machine has characteristics of structure, easy operation and steady performance.

Main Technical Parameters

Model: ABE-1.0-600
Max. Coil width: 600mm
Thickness of steel coil: Max. 1.0mm
Expanding speed: 260-300 strokes/minute
Motor power: 2.2KW
Expanding force: 6.3T
Overall size of machine(L*W*H): 1200*900*1700mm
Machine weight: 2 tons
Controlled by PLC+touch screen; Length calculate+automatic cutting

轻型钢板网机主要描述

本机床主要用于将冷轧钢板、铝板等金属板材经冲制、拉伸生产为六角形、菱形、半圆形、菱形半圆组合形等多种形状的板网产品。所冲网格广泛用于建筑、五金、机床、电子工业品、家电产品的防护和装饰等。本机床冲制板网材料为抗拉强度在450牛/平方毫米以下,伸长率在25%以上的冷轧钢板或相应的其他金属材料。机床采用曲轴连杆机构实现板材的冲剪、凸轮实现摆动,进料采用步进电机,可实现进料距离的任意调整。该设备结构简单,操作容易、性能稳定。

主要技术参数

型号: ABE-1.0-600
最大材料宽度: 600mm
原材料厚度: 最大1.0mm
冲网速度: 260-300次/分
电机功率: 2.2KW
冲力: 6.3T
外形尺寸(长*宽*高): 1200*900*1700mm
设备重量: 2.0吨
文本显示器;网孔长度计算+切断功能。



ABE-1.0-1000 (16T) 钢板网机 / Expanded Mesh Machine

主要设备描述：

ABE-1.0-1000型16吨冲力的钢板网冲剪机属于轻型冲剪机，生产的钢板网普遍用于建筑、五金、机床、电子工业品、家电产品的防护和装饰等行业，用途广泛。我公司在传统的设计工艺上对钢板网机器进行改进，可配备数控步进（伺服）电机送料，全自动润滑和气动离合等新技术，机器的操控性，稳定性，安全性都有很大的提高，机器的结构更加合理，操作简便。

主要技术参数

1. 全自动放料机/放料架

最大放料宽度：1000mm
电机功率：1.5KW
最大承重：3T
内径：580-610mm
重量：0.91T
外形尺寸（长*宽*高）：1800*1000*1500mm

2. 钢板网机

最大冲网宽度：1000mm
原材料：镀锌钢板
最大冲网厚度：1.0mm
最大冲网速度：260次
电机：5.5KW
重量：约3T

Main technical parameters:

1. Auto de-coiler

Max. width: 1000mm;
Motor power: 1.5KW;
Max. loading weight: 3T
Inner diameter: 580-610mm
Machine weight: 0.91T
Size(L x W x H): 1800x1000x1500mm

2. Expanded metal mesh machine

Model: ABE-1.0-1000
Thickness of material: ≤1.0mm
Width of material: ≤1250mm
Max. Stroke per min: 260 times / min
Motor power: 5.5KW
Machine weight: about 3.0T



ABE-1.5-1250 (25T) 钢板网机 / Expanded Mesh Machine

主要设备描述：

ABE-1.5-1250型25吨冲力的钢板网冲剪机属于轻型钢板网冲剪机，生产的钢板网普遍用于建筑、五金、机床、电子工业品、家电产品的防护和装饰等行业，用途广泛。

Main technical parameters

Model: ABE-1.5-1250
Expanding force: 25T
Thickness of material: ≤1.5mm
Width of material: ≤1250mm
Stroke per min: 260-300 strokes / min
Motor power: 5.5KW
Machine weight: about 3.0T
Overall size(L*W*H): 2430*1350*1850mm

主要技术参数

最大材料宽度：1250MM
最大材料厚度：1.5mm
原材料：镀锌板，低碳钢板
最大冲网速度：约260-300次/分钟
冲力：25T
电机功率：5.5KW

模具尺寸：根据买方提供的图纸或样品设计模具
材质：DC53 或者Cr12Mov
外形尺寸（长*宽*高）：约2430*1350*1850mm
重量：约3吨

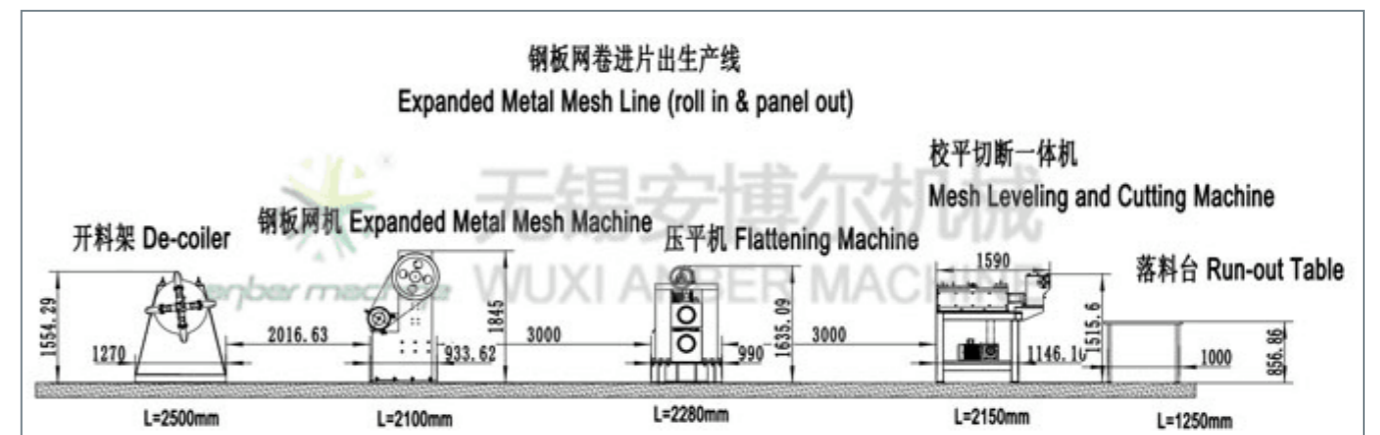



ABE-4.0-1300 (60T) 钢板网机 / Expanded Mesh Machine

Process:

10T hydraulic De-coiler→Straightening machine with 7 roller→
ABE-4.0-1300 Expanded metal mesh machine→Collection table

Main technical parameters:

Model: ABE-4.0-1300	Overall size of machine(L*W*H): 2500*1400*2150mm
Material: low carbon steel	Machine weight: 4.7 tons
Max. width: 1300mm	Typical Mesh size (LWDxSWD): 50x25mm, 60x30mm, 70x35mm
Max. Thickness of steel: 4.0mm	Mold material: DC53 or according to customer's demand
Expanding speed: 85 strokes/minute	
Motor power: 11KW	
Expanding force: 60T	

工艺流程:

10T液压开卷机→7辊校平机→ABE-4-1300钢板网机→简
易收料台

主要技术参数:

型号: ABE-4-1300	公称压力: 60T
冲剪板料宽度: ≤1300mm	外形尺寸(长*宽*高): 2.5m*1.4m*2.15m
冲剪板料厚度: 4.0mm	整机重量: 4.7 tons
滑块行程次数: 85 strokes/minute	网孔尺寸(长截距x短截距): 50x25mm, 60x30mm, 70x35mm
功率: 11KW	模具材质: DC53

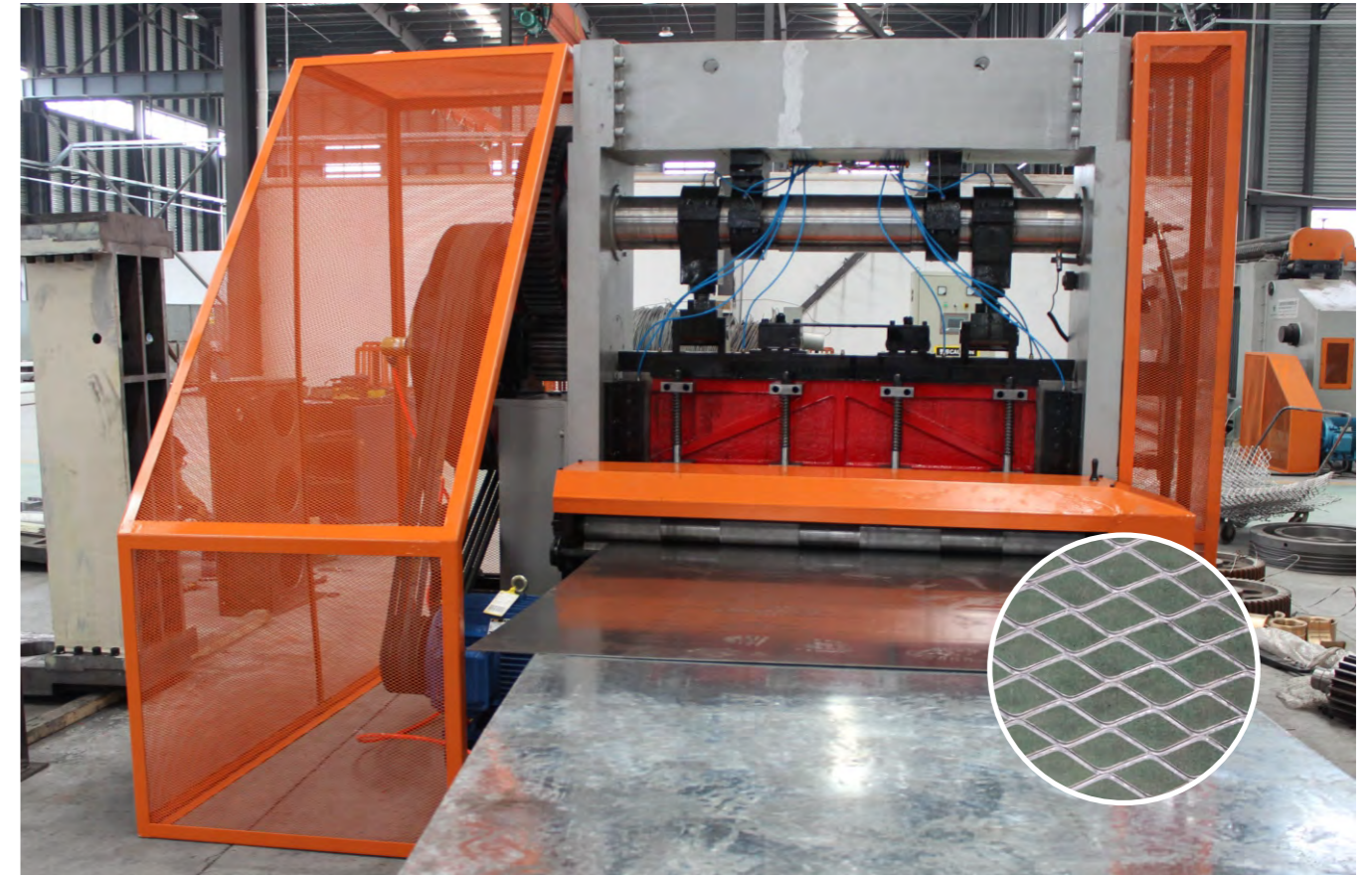
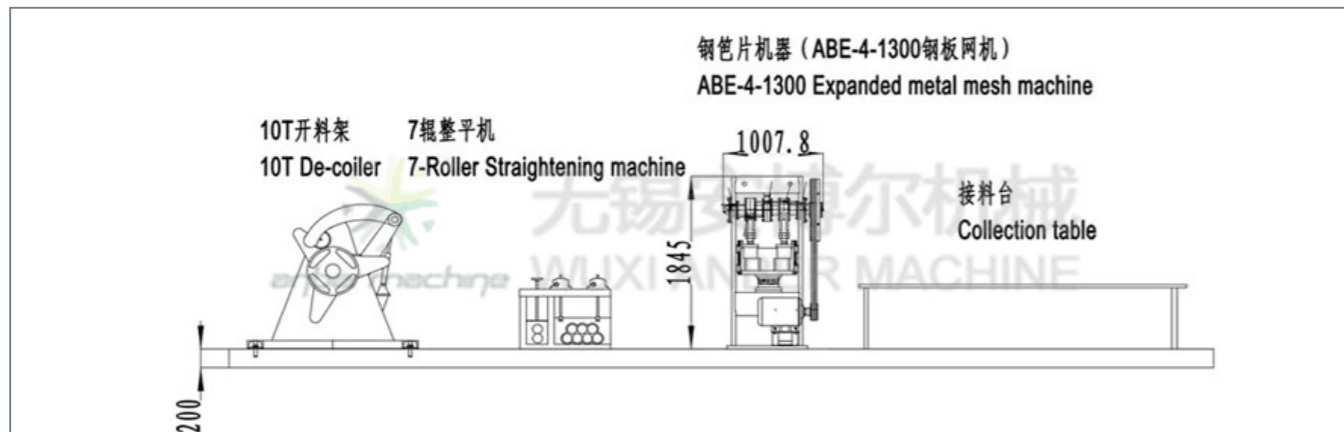

ABE-2.5-1500 (40T) 钢板网机 / Expanded Mesh Machine

主要设备描述:

ABE-2.5-1500型40吨冲力的钢板网冲剪机属于轻型钢板网冲剪机,生产的钢板网普遍用于建筑、五金、机床、电子工业品、家电产品的防护和装饰等行业,用途广泛。我公司在传统的设计工艺上对钢板网机器进行改进,可配备数控步进(伺服)电机送料,全自动润滑和气动离合等新技术,钢板网机的操控性,稳定性,安全性都有很大的提高,机器的结构更加合理,操作简便。

Composition of machine

The expanded metal mesh machine is composed of main machine frame, driving system, crankshaft, upper blade frame(movable frame), down blade frame, feeding device, material moving device, lubrication system and electric control cabinet.

Main technical parameters

Model: ABE-2.5-1500
Material: low carbon steel, galvanized steel, stainless steel. etc
Max. width: 1500mm;
Max. Thickness of steel: 2.5mm;
Expanding speed: 100-150 strokes/minute;
Motor power: 11KW;
Expanding force: 40T;
Overall size of machine(L*W*H): 2900*1400*2150mm
Machine weight: about 6 tons

设备组成

钢板网冲剪机主要由机架、传动系统、曲轴连杆、刀架、送料机构、摆料机构及配电装置组成。

主要技术参数

公称压力: 400KN(40T)
冲剪板料厚度: ≤2.5mm, 低碳钢板
冲剪板料宽度: ≤1500mm
滑块行程次数: 100-150次/分
滑块行程: 40mm
压力: 1.5KN
纵向送料距离: 0-3.2mm
电机功率: 11KW
外形尺寸(长*宽*高): 2900*1400*2150mm
机器重量: 约6T



ABE-6.0-2000 (100T/160T)钢板网机 / Expanded Mesh Machine

Material moving type / 原材料摆动片进型

Description

The fence mesh machine is used produce the expanded metal mesh for fence, the fence is usually applied in construction, hardware, door, windows, safety fence, highway guardrail and lathes. This kind of fence mesh usually need surface treated to used as door and the highway guardrail, etc.
The machine is in high speed with satisfied expanded mesh. The shearing force of the expander is related to the thickness of the materials as well as the LWD. Considering the same thickness of the raw materials, the shearing force will increase with the decreased LWD.

Main technical parameter

Model: ABE-6.0-2000
Range of the thickness: 0.5-6mm
Cutting width: 2000mm
SWD: 10-70mm
LWD: 20-150mm
Working speed: 45-60 strokes/min
Feeding distance: 0-4mm
Motor power: 22kw/30kw
Net weight: 12T
Punching force: 100T /160T
Overall size: 3800mmx1900mmx2300mm

设备组成

钢板网机主要由机架、传动系统、曲轴连杆、刀架、送料机构、摆料机构及配电装置组成。各部分介绍如下：

1. 机架部分：由左立柱、右立柱、上梁、下梁组成。
2. 传动系统：由电机带动飞轮经气动离合器再经两级齿轮传动带动曲轴旋转。
3. 曲轴连杆部分：由曲轴、连杆、连杆瓦、连杆轴销组成。
4. 刀架部分：由上刀架下刀架及压料部分组成。
5. 送料机构部分：由步进电机经变速箱带动丝杆旋转推动拖板前进或后退。
6. 摆料机构：由步进电机经变速后带动齿条，推动横向拖板左右摆动。
7. 电器部分：控制设备的整体运转。

主要技术参数

型号：ABE-6.0-2000
公称压力：100吨/160吨
冲剪板料厚度：≤6mm (原材料：Q235冷轧钢板、铝板)
冲剪板料宽度：≤2000mm
电机功率：22KW/30KW
冲剪速度：45-60次/分
外形尺寸 (长*宽*高)：3800mmx1900mmx2300mm



ABE-6.0-2000 (100T)钢板网机 / Expanded Mesh Machine

Mold moving type / 模具摆动卷进型

ABE-6.0-2000 Expanded Metal Mesh Machine

Nominal Pressure Force: 100 Tons
Feeding by coil and sheet
Max. Width of the steel plate: 2000 mm
Thickness of material: ≤6.0mm for mild steel
Max. Strokes per minute: 80 strokes/min
Motor power: 30 kw
Max. LWD: 160 mm
Overall dimension of main machine (L*W*H): 4150x1900x2570mm
Machine weight: about 14 tons
Automatic lubrication system

2米钢板网机

公称压力：100T
冲剪板料厚度：≤6.0mm，冷轧板
冲剪板料宽度：≤2000mm
滑块行程次数：80次/分
滑块行程：80mm
压料力：8.5KN
连杆调节距离：20mm
纵向送料距离：0-20mm

横向摆动距离：0-80mm
电机功率：30KW
外形尺寸 (长*宽*高)：4150x1900x2570mm
机器重量：14T
进料方式：卷进料或者片进料
送料方式：机械送料，伺服 (步进) 电机送料供客户选择



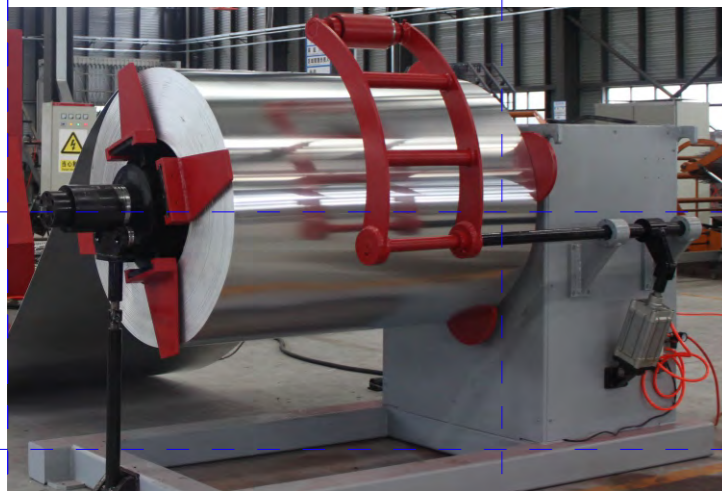

5T Auto Decoiler / 5T自动开料架

Max. Loading weight: 5T
 Motor power: 1.5KW
 Max. Width: 1500mm
 I.D.: 515-670mm, adjustable
 Overall size of machine(L*W*H): 3150x1630x1750mm
 Machine weight: 2.1 T

最大承重：5T
 电机功率：1.5KW
 最大材料宽度：1500mm
 内径：515-670mm，可调节
 外形尺寸(长*宽*高)：3150x1630x1750mm
 机器重量：2.1T

**2M Expanded Mesh Leveling Machine
网片校平机/整平机**

Leveling roller number: 7 pcs+2 pcs feeding roller
 Roller diameter: 150mm
 Material of roller: 40Cr
 Hardness of roller: HRC58°
 Motor power: 7.5KW
 Overall size(L*W*H): 2600x1380x1450mm
 Machine weight: 4.0T

整平辊采用40Cr实心材料，7辊校平+2辊送料，辊径：150mm。辊硬度58°，硬度高，耐磨。入料辊调节方式蜗轮蜗杆升降
 电机功率：7.5KW
 外形尺寸(长*宽*高)：2600x1380x1450mm
 机器重量：4.0T



Layout of expanded mesh machine / 布局图

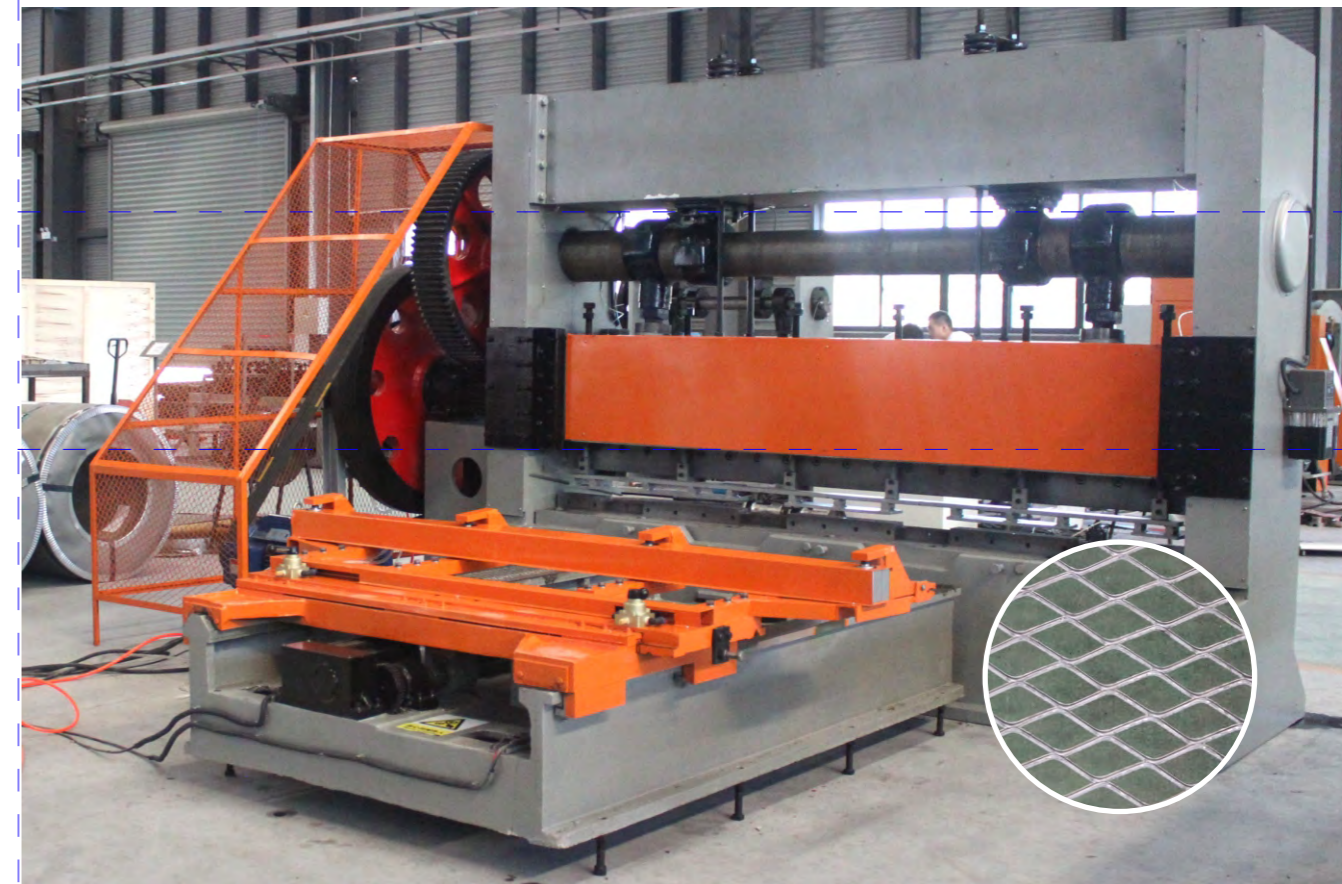
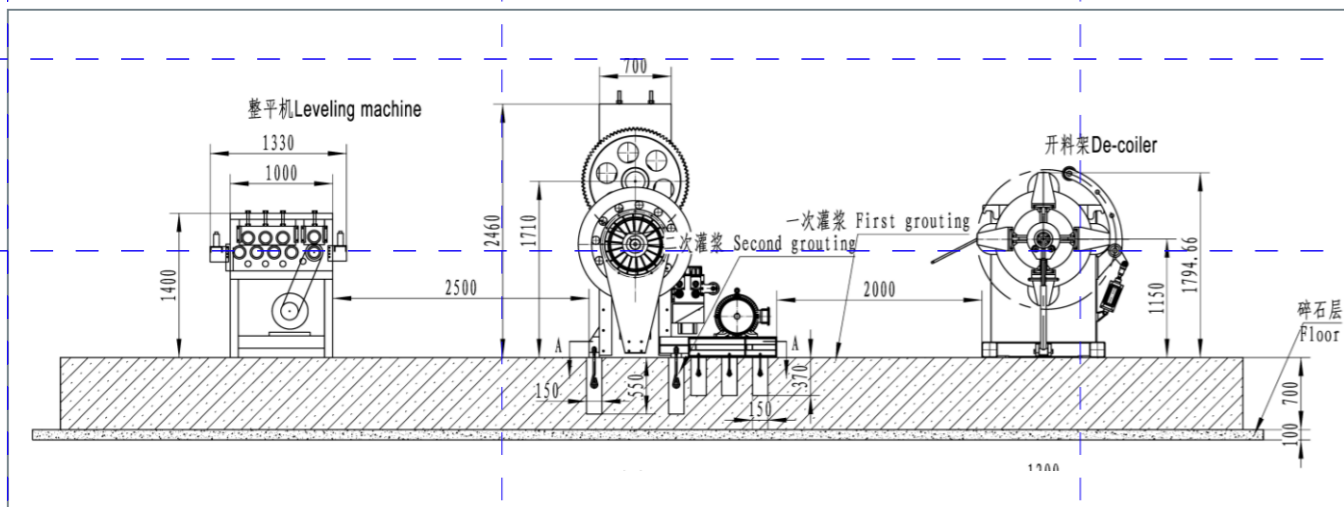

ABE-6.0-2500 (100T)钢板网机 / Expanded Mesh Machine

Description

The expanded metal mesh machine is used produce the expanded metal mesh, also is called expanded metal lath, can be used in construction, hardware, door and windows and lathes. Some products with surfacing processed can be wildly used in decoration of the building or house.
 The machine is in high speed with satisfied expanded mesh. The shearing force of the expander is related to the thickness of the materials as well as the LWD. Considering the same thickness of the raw materials, the shearing force will increase with the decreased LWD.

Main technical parameter

Model: ABE-6.0-2500
 Range of the thickness: 0.5-6mm
 Cutting width: 2500mm
 Working speed: 40 strokes per minute
 LWD: 200mm
 SWD: 10- 120mm
 Punching force: 100T
 Motor power: 22kw
 Feeding distance: 0-8mm
 Net weight: 18T
 Overall size: 4300mmx1900mmx2300mm
 Size of feeding: 2400mmx1700mmx800mm

设备组成

钢板网机主要由机架、传动系统、曲轴连杆、刀架、送料机构、摆料机构及配电装置组成。各部分介绍如下：
 1. 机架部分：由左立柱、右立柱、上梁、下梁组成。
 2. 传动系统：由电机带动飞轮经气动离合器再经两级齿轮传动带动曲轴旋转。
 3. 曲轴连杆部分：由曲轴、连杆、连杆瓦、连杆轴销组成。
 4. 刀架部分：由上刀架下刀架及压料部分组成。
 5. 送料机构部分：由步进电机经变速箱带动丝杆旋转推动拖板前进或后退。
 6. 摆料机构：由步进电机经变速后带动齿条，推动横向拖板左右摆动。
 7. 电器部分：控制设备的整体运转。

主要技术参数

型号：ABE-6.0-2500
 公称压力：100T
 冲剪板料厚度：0.5-6.0 mm
 冲剪板料宽度：≤2500 mm
 滑块行程：90 mm
 压料力：30 KN
 连杆调节距离：40mm
 纵向送料距离：0-8 mm
 横向摆动距离：0-100 mm
 每小时连续冲剪钢板长度：2.1-12.6 m
 电机型号：Y160L-4
 电机功率：22 KW
 整机重量：18000 kg
 机器外形尺寸(长×宽×高)：4300mmx1900mmx2300mm
 送料器尺寸：2400mmx1700mmx800mm



ABE-8.0-2500 (260T)钢板网机 / Expanded Mesh Machine

Description

ABE-8-2500 expanded metal machine is heavy-duty expanded metal machine. This kind of metal mesh is mainly used for shipbuilding, mining, machinery, construction, transportation, oil, urban construction, hardware, protective and so on. The machine can also punch stainless steel, aluminum and other materials board network, its use will be more extensive. It adds automatic lubricating system and feeding system by numerical step motor on basis of original skilled technique. It gets good effect after being used. It has improved a lot on control and security. Its structure has characteristics of rationality, good appearance, environmental protection, energy saving.

Main technical parameters:

Model: ABE-8.0-2500
 Normal pressure: 260 Tons
 Thickness of material: ≤8mm
 Width of material: ≤2500mm
 Distance of feed: 0-7mm
 Stroke per min: 30-40 times / min
 Mesh size of LW: Max. 100mm
 Motor power: 55KW
 Rotation speed of motor: 1480r/min
 Weight: about 26 tons
 Overall dimension (L*W*H): 4400*3500*2700mm

设备组成

钢板网机主要由机架、传动系统、曲轴连杆、刀架、送料机构、摆料机构及配电装置组成。各部分介绍如下：
 1. 机架部分：由左立柱、右立柱、上梁、下梁组成。
 2. 传动系统：由电机带动飞轮经气动离合器再经两级齿轮传动带动曲轴旋转。
 3. 曲轴连杆部分：由曲轴、连杆、连杆瓦、连杆轴销组成。
 4. 刀架部分：由上刀架下刀架及压料部分组成。
 5. 送料机构部分：由步进电机经变速箱带动丝杆旋转推动拖板前进或后退。
 6. 摆料机构：由步进电机经变速后带动齿条，推动横向拖板左右摆动。
 7. 电器部分：控制设备的整体运转。

主要技术参数

型号：ABE-8.0-2500
 公称压力：260吨
 冲剪板料厚度：≤8mm
 冲剪板料宽度：≤2500mm
 冲剪次数：30-40次/分
 曲轴偏心轴：50mm
 压料力：3吨
 连杆调节距离：40mm
 纵向送料距离：0-7mm
 横向摆动距离：1-100mm
 电机功率：55KW
 转速：1480转/分
 重量：约26吨
 外形尺寸（长*宽*高）：4400*3500*2700mm

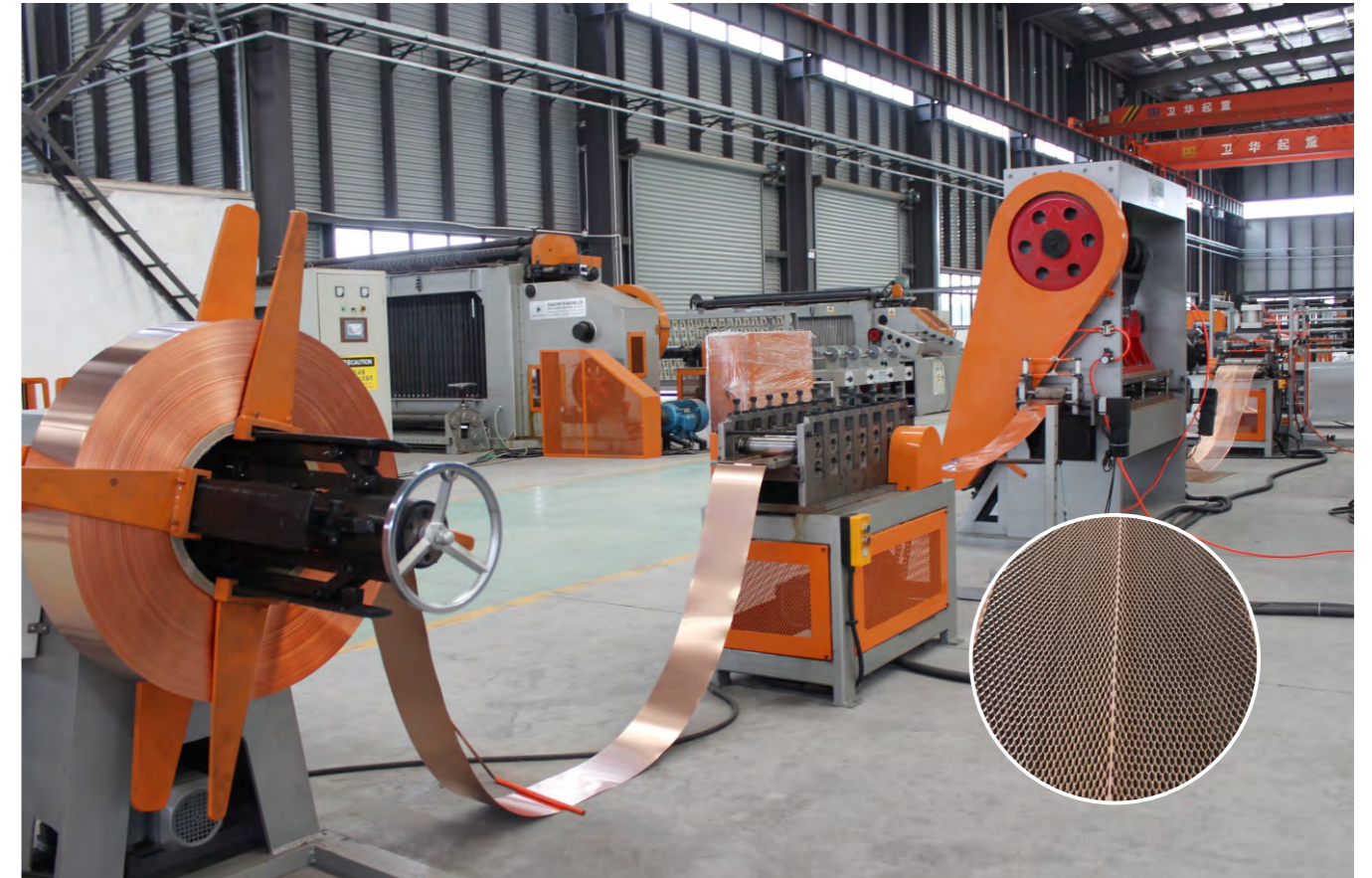

铜极网生产线 / Copper Battery Mesh Expanding line

设备的主要性能、特点

铜极网是采用铜T1M为原料，经加工成为有两侧卷边、中间V型槽的铜网。其主要用途是作为蓄电池正极使用。使用铜极网作为蓄电池正极板栅的时候，能够使电池的正极活性物质利用率提高，增加电池的使用效率。

产品的用途和材料要求

本生产线生产的铜极网专用于蓄电池正极板栅。可选材厚度为0.2mm，理论宽度为176mm的纯铜板材。

Description

Main property and characteristics: Copper pole network is made of copper T1M, processed into copper mesh with both sides of the bead and the middle of the V-groove. It's main purpose is to be used in the battery positive. Copper pole network as battery positive electrode grid can improve the use ratio of the positive electrode active substance and efficient use of the battery.

The purpose of the product and material requirements

The copper pole network produced by this production line specialized in battery positive electrode grid. Alternatively the thickness of 0.2mm, the width of the theoretical material of the copper plate of 176mm. Material is copper plate with thickness of 0.2mm and width of 176mm.

冲网机

冲网速度：240次/分钟
 模具驱动：V带驱动
 冲床冲力：35T
 速度：4.08m/min
 送料距离：17mm
 电机功率：5.5KW，转速：960r/min
 模具：有效行程：10mm，材质：Cr12MO1V1，硬度：HRC58-62
 设备尺寸：1750x1200x1900mm
 重量：2800Kg

Expanded main machine

Expanding speed: 240times/min
 Mold drive: V-belt drive
 Stroke power: 35T
 Speed: 4.08m/min
 Feeding distance: 17mm
 Electrical machine: Power:5.5KW, Rotate:960r/min
 Mold: Effective journey:10mm, Material: Cr12MO1V1, Hardness:HRC58-62
 Size: 1750x1200x1900mm
 Weight: 2800Kg

整平剪切机组

步进电机：110BYGH6480
 整平辊直径：Φ60mm
 驱动形式：链传动
 压紧形式：气动
 剪切动力：气动
 外形尺寸：1400x740x1191mm
 成型辊数：7根整平（上三下四）；1组进料，1组出料
 重量：400kg

Leveling and shearing machine

Stepping motor: 110BYGH6480
 Leveling roll diameter: 110BYGH6480
 Driving form: Chain drive
 Compact form: Pneumatic
 Shearing power: Pneumatic
 Outer size: 1400x740x1191mm
 NO. of forming roller: 7 roots for leveling(up three down four); 1 program for feeding, 1 program for roll-out
 Weight: 400kg

辅助设备 / Accessory Machine

5吨自动开卷机 5T Auto decoiler



5T Auto Decoiler
 Max. Width: 1300mm
 Max. Loading weight: 5T
 Main motor power: 1.5KW
 I.D.: 480-510mm, adjustable
 Overall size of machine(L*W*H): 3150*1630*1750mm
 Machine weight: 2.1 tons

5T自动开卷机
 最大原材料宽度: 1300mm
 最大承重: 5T
 电机功率: 1.5KW
 内径: 450-550mm, 可调节
 外形尺寸(长*宽*高): 3150*1630*1750mm
 机器重量: 2.1T

7吨自动开料架 7T Auto decoiler



7T Auto decoiler
 Max. Loading weight: 7T
 Motor power: 1.5KW
 Max. Width: 1500mm
 I.D.: 515-670mm, adjustable
 Overall size of machine(L*W*H): 3150*1630*1750mm
 Machine weight: 2.1 tons

7T自动开卷机
 最大承重: 7T
 电机功率: 1.5KW
 最大材料宽度: 1500mm
 内径: 515-670mm, 可调节
 外形尺寸(长*宽*高): 3150*1630*1750mm
 机器重量: 2.1T

7吨地辊开料架 7TRoller type decoiler



7T Roller type decoiler
 Max width of raw material:1300mm
 Max outer diameter:1250mm
 Inner diameter:450-650mm
 Thickness of raw material:1.2-1.5mm
 Control:sensor
 Motor power:5.5KW
 Working pressure of equipment:0.4~0.6Mpa
 Max bearing:7T
 Size (L*W*H) : 2550*1850*870mm
 Machine weight:about 1.3 T

7T地辊开卷机
 最大材料宽度: 1300mm
 最大卷外径: 1250mm
 卷内径: 450-650mm
 原材料厚度: 1.2-1.5mm
 开卷控制: 传感器
 设备工作气压: 0.4~0.6Mpa
 功率: 5.5KW
 开卷速度:2.5RPM
 最大卷重: 7吨
 外形尺寸(L*W*H):2550*1850*870mm
 机器重量: 约1.3吨

10吨液压开卷机 10T Hydraulic De-coiler



15T Hydraulic decoiler with coil car
 Max. Material Width: 1250mm
 Inner diameter: 508mm
 Max. Loading weight: 10T
 Motor power:5.5KW

15T液压自动开卷机
 最大材料宽度: 1250mm
 内径: 508mm
 最大装载重量: 10T

15吨液压开卷机 15T Hydraulic De-coiler



15T Hydraulic decoiler with coil car
 Max. Material Width: 1250mm
 Inner diameter: 508mm
 Max. Loading weight: 15T
 Motor power:5.5KW

15T液压自动开卷机
 最大材料宽度: 1250mm
 内径: 508mm
 最大装载重量: 15T

Model 型号	ABE-KL600	ABE-KL1000	ABE-KL1300	ABE-KL2000
Width 宽度	600mm	1000mm	1300mm	2000mm
Loading Weight 承重	3T	2T	5T	10T
Inner Diameter 内径	580mm-610mm, adjustable			

2辊压平机 2-rollers Flattening Machine



Model 型号	ABE-YP800	ABE-YP1000	ABE-YP1300	ABE-YP1500
Width 宽度	800mm	1000mm	1300mm	1500mm
Thickness 厚度	Max. 1.0mm	0.5-3mm	0.5-3mm	0.5-3mm
Roller Diameter 压辊直径	250-300mm	300-400mm	300-400mm	400-500mm
Machine Weight 机器重量	2.6T	2.5T/2.8T	4T	6.5T/5.6T
Motor Power 电机功率	4kw	4kw	5.5kw	7.5kw

4辊压平机 4-rollers Flattening Machine



最大原材料宽度：1250mm或者根据客户需求
 原材料厚度：最大1.5mm
 工作辊（中间两辊）长：1250mm
 工作辊（中间两辊）辊径：Φ250mm
 支撑辊（上下两辊）长：1150mm
 支撑辊（上下两辊）辊径：Φ450mm
 工作辊硬度：HRC63.3~63.8
 支撑辊硬度：HRC53.8~54.8
 速度：变频调速
 压力辊调节方式：手轮或者电机自动调节，根据客户要求订制
 辊材质：合金高频淬火
 主电机功率：7.5KW
 收卷机功率：3KW
 外形尺寸（长*宽*高）：2300*1650*1930mm
 机器重量：约6.3吨

Max. mesh width: 1250mm
 Material thickness: Max. 1.5mm
 Hardness of working rolls: HRC63.3~63.8
 Hardness of support rolls: HRC53.8~54.8
 Work speed: frequency control
 Motor power: 7.5KW
 Roller adjustment: by hand wheel or auto motor, according to customer's requirement
 Overall size(L*W*H): 2300*1650*1930mm
 Weight of machine: about 6.3T

Length of working rolls (two middle rolls): 1250mm
 Diameter of working rolls (two middle rolls): Φ250mm
 Length of support rolls (up and down rolls): 1150mm
 Diameter of support rolls (up and down rolls): Φ450mm
 Material of roll: high frequency quenching alloy
 Motor power of recoiler: 3KW

整平机 Straightening Machine



Model 型号	ABE-JP1250	ABE-JP2500
Width 宽度	1250mm	2500mm
Roller QTY 压辊数量	9PCS	2500MM
Roller Dia. 压辊直径	100mm	200mm
Surface Hardness 压辊表面硬度	HC50	HC50
Motor Power 电机功率	8kw	11kw
Reducer type 减速机型号	400	400
Net Weight 整机重量	6T	15T
Overall Dia. 外形尺寸	1.2mx1.75mx1.3m	1.2mx3mx31.5m

整平横切一体机 Expanded mesh leveling and cutting machine



Max width of expanded metal mesh : 1250mm
 Max thickness of raw material : 1.0mm
 Quantity of rolls: 17 rolls
 Working method: 2 rolls feeding+15 rolls leveling
 Diameter of rolls : 50-70mm
 Surface Hard: HRC58
 Motor power: 7.5KW
 Weight : 1.5T
 Hydraulic cutting device
 Machine size(L*W*H) : 2100*890*1410 mm
 Working speed: frequency control

最大钢板网宽：1250mm
 最大原材料厚度：1.0mm
 2辊送料+15辊整平
 辊径：50-70mm
 辊表面硬度：HRC58
 机器重量：1.5T
 机器尺寸：2100*890*1410 mm
 主电机功率：7.5KW
 变频调速
 液压切断装置

整平分条横切一体机 Straightening and slitting machine

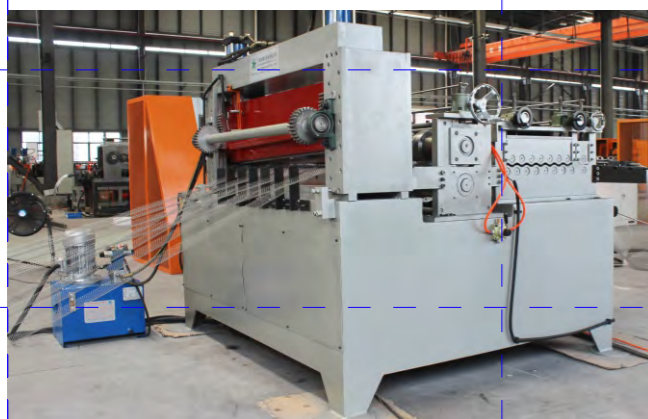

该设备将整平及和分条机整合在一起，有效地节约了占地面积，提高了生产的效率。

电机功率：2.2KW
驱动型式：链条传动

The straightening and slitting machine combined the function of straightening and slitting, it saved the space and increased the production efficiency.

Motor power: 2.2kw
Driven type: chain type

收料架 Recoiler

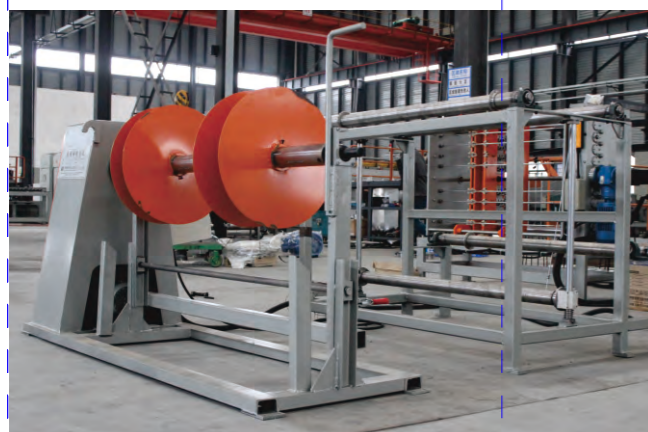

Model 型号	ABE-SL500	ABE-SL1000	ABE-SL1500
Loading Weight 承重	500kg	1000kg	1500kg
Inner Dia. 内径	400mm Can be adjustable/可调节		
Width 宽度	500mm	1000mm	1250mm

模具 Mould

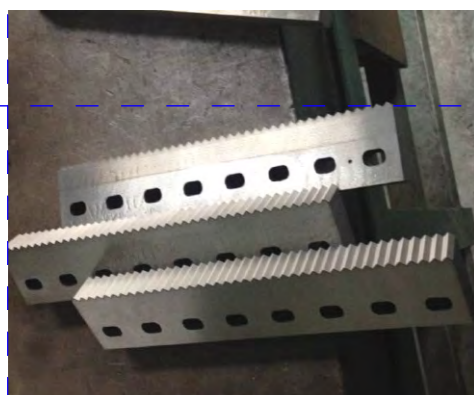

轴瓦 Copper Tile



夹具 Clip



钢板网示意图 Legend of expanded metal

FLATTENED MESH/压平后网孔

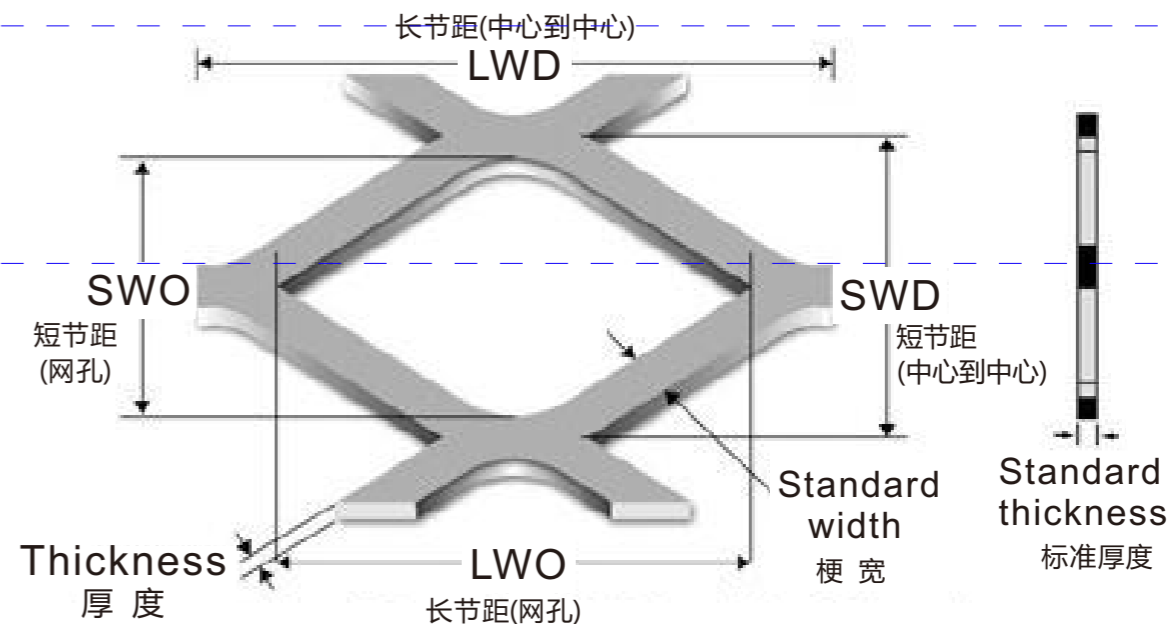

SWD: short way of diamond LWD: long way of diamond
长节距(中心到中心) 短节距(中心到中心)

STANDARD MESH/标准网孔

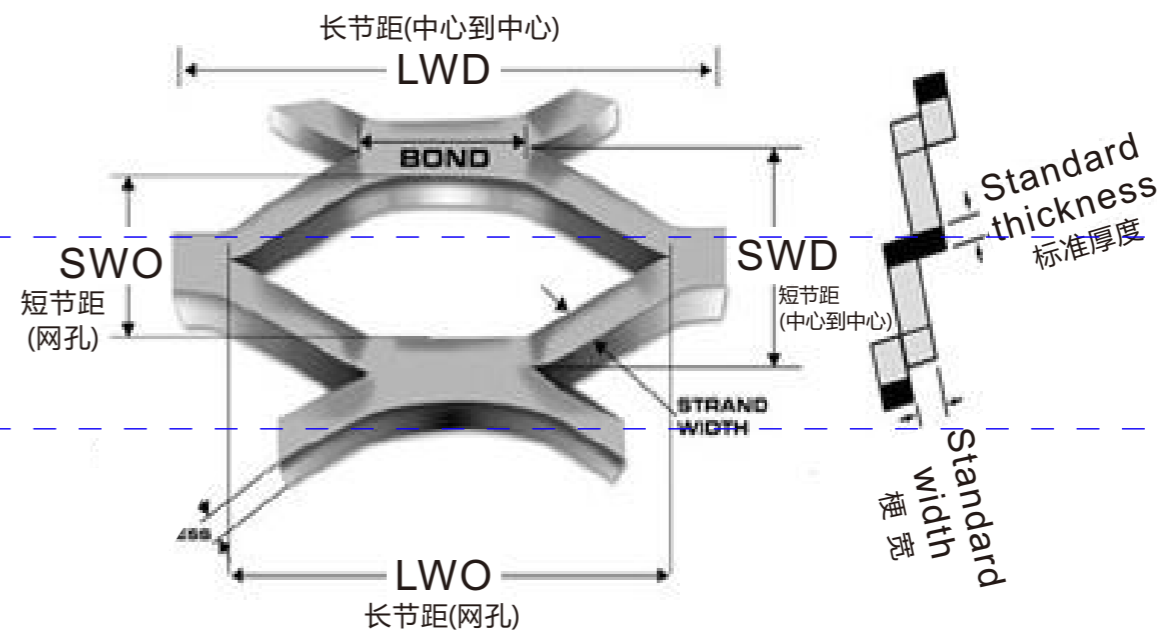

SWO: short way of opening LWO: long way of opening
长节距(中心到中心) 短节距(中心到中心)

钢板网产品 Typical Expanded Metal Mesh

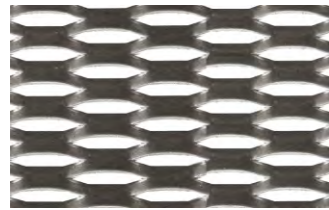

Model: ABE-P001
Mesh shape: hexagonal
Mesh size: 45mmx13mmx5mm



Model: ABE-P002
Mesh shape: hexagonal
Mesh size: 45mmx18mmx4mm

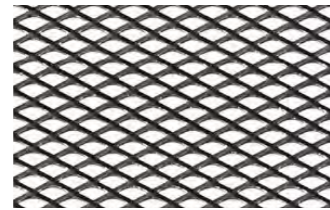

Model: ABE-P003
Mesh shape: rhomboidal
Mesh size: 6mmx3mmx0.8mm

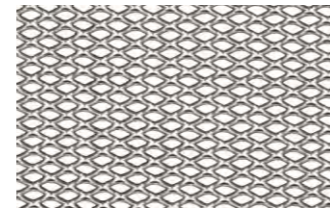

Model: ABE-P004
Mesh shape: rhomboidal
Mesh size: 8mmx4mmx1mm

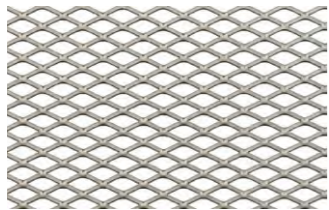

Model: ABE-P005
Mesh shape: rhomboidal
Mesh size: 10mmx5mmx1mm

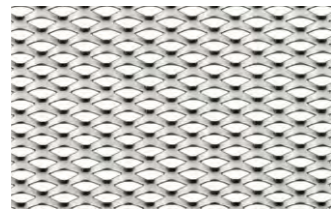

Model: ABE-P006
Mesh shape: rhomboidal
Mesh size: 12mmx6mmx2mm

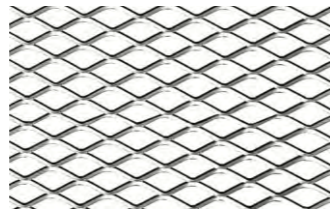

Model: ABE-P007
Mesh shape: rhomboidal
Mesh size: 16mmx8mmx1mm

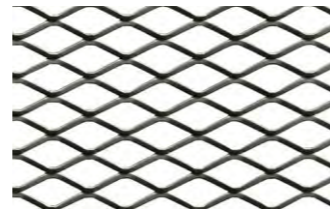

Model: ABE-P008
Mesh shape: rhomboidal
Mesh size: 20mmx10mmx2mm

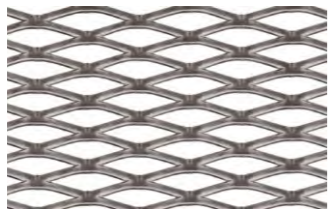

Model: ABE-P009
Mesh shape: rhomboidal
Mesh size: 29mmx9mmx2.5mm



Model: ABE-P010
Mesh shape: rhomboidal
Mesh size: 30mmx17mmx2.5mm



Model: ABE-P011
Mesh shape: rhomboidal
Mesh size: 40mmx17mmx2mm

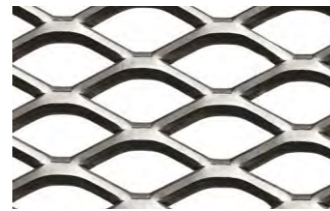

Model: ABE-P012
Mesh shape: rhomboidal
Mesh size: 45mmx20mmx4mm



Model: ABE-P013
Mesh shape: rhomboidal
Mesh size: 50mmx18mmx5mm



Model: ABE-P014
Mesh shape: rhomboidal
Mesh size: 62mmx20mmx7mm



Model: ABE-P015
Mesh shape: rhomboidal
Mesh size: 62mmx23mmx3mm



Model: ABE-P016
Mesh shape: rhomboidal
Mesh size: 110mmx25mmx7mm

Chart of expanded metal mesh 钢板网选型表

SR. NO. 序号	Item code 型号	LWD 长节距 (mm)	SWD 短节距 (mm)	Strand width 梗宽 (mm)	Thickness of sheet 钢板网厚度 (mm)	Metal sheet/W x L 钢板尺寸/宽x长
1	EM-5/3.5/1.6-A	5	3.5	1.6	1.5	1.22x2.44
2	EM-6/3.5/0.43-A	6	3.5	0.43	0.5	
3	EM-6.4/3.4/0.71	6.4	3.4	0.71	0.45	
4	EM-8.8/7.2/0.8-A	8.8	7.2	0.8	0.47	
5	EM-13/7/1.16	13	7	1.16	0.49	
6	EM-13/8/1.14	13	8	1.14	1.17	
7	EM-13/8.2/0.9	13	8.2	0.9	0.7	
8	EM-13/8.7/1	13	8.7	1	0.7	
9	EM-14/10/1.15-A	14	10	1.15	1	
10	EM-15.8/9/1.3	15.8	9	1.3	1.47	
11	EM-15.9/8.7/1.65	15.9	8.7	1.65	1.52	
12	EM-20/14/2.8-A	20	14	2.8	2	
13	EM-20/14/4.2-A	20	14	4.2	2	
14	EM-30/12.7/2.3	30	12.7	2.3	1.56	
15	EM-30.5/12.7/1.91	30.5	12.7	1.91	1.9	
16	EM-31.5/10.4/1.17	31.5	10.4	1.17	0.45	1.22x3
17	EM-45/11/0.9-A	45	11	0.9	0.37	1.22x2.44
18	EM-50.8/22/3.58	50.8	22	3.58	2.8	
19	EM-50.8/23.4/2.49	50.8	23.4	2.49	1.78	
20	EM-50.8/27/2.97	50.8	27	2.97	1.9	
21	EM-55/24.5/5.35-A	55	24.5	5.35	1.17	
22	EM-56.3/15.9/2.54	56.3	15.9	2.54	1.52	
23	EM-60/25/2.5	60	25	2.5	1.68	
24	EM-62/24/8.5-A	62	24	8.5	1.7	
25	EM-71/23.4/3.58	71	23.4	3.58	2.66	
26	EM-76.2/39.4/3.18	76.2	39.4	3.18	2.8	
27	EM-76.2/39.4/2.46	76.2	39.4	2.46	1.9	
28	EM-76.2/33.8/2.46	76.5	33.8	2.46	1.9	
29	EM-80/27/15.58-A	80	27	15.58	4.85	
30	EM-85.5/25/11-A	85.5	25	11	2	
31	EM-100/52/5	100	52	5	3.07	
32	EM-100/53/5.23-A	100	53	5.23	6	
33	EM-100/53/2.46	100	53	2.46	2.18	
34	EM-110/46/20-A	110	46	20	2.63	
35	EM-115/48/19.2-A	115	48	19.2	1.6	
36	EM-200/70/29.5-A	200	70	29.5	2.75	

Expanded metal mesh & Gratings can be produced in Mild Steel, Stainless Steel (Grade 304, 316, 409, 439 etc.), Aluminum Brass, all types of special grade steels, Etc.

材料：低碳钢、不锈钢、铝等

Selection Guidance for Expanded Metal Mesh Production line
钢板网生产线询盘需求表

Important customer Details 重要客户信息				
Name 名字	_____ *		Country 国家	_____ *
E-mail 邮箱	_____		Power supply 电力要求	_____ V * _____ Hz *
Project 项目性质	<input type="checkbox"/> First purchase of expanded metal mesh line 新建项目		<input type="checkbox"/> Expanding plan on expanded metal mesh line 扩展项目	
Raw material to expand 原材料				
Material 材质	<input type="checkbox"/> Low carbon Steel 低碳钢 <input type="checkbox"/> Galvanized Steel 镀锌板 <input type="checkbox"/> Aluminium 铝 <input type="checkbox"/> Stainless steel 不锈钢 <input type="checkbox"/> Copper 铜 <input type="checkbox"/> Other Steel 其他材质: _____ Steel NO. 牌号: _____			
Size 尺寸	Max. width 最大宽度: _____ mm *		Max. thickness 最大厚度: _____ mm *	
In coil or in sheet 卷料/片料	<input type="checkbox"/> In coil 卷料 (_____ kg per coil 卷重) 内径 _____		<input type="checkbox"/> In sheet 片料	
Expanded metal Mesh 钢板网要求				
In coil or in sheet 卷料/片料	<input type="checkbox"/> In coil 卷料 (_____ kg per coil)		<input type="checkbox"/> In sheet 片料 (_____ mm length)	
Mesh size 网片规格	LWD长节距	SWD短节距	Strand width 梗宽	Thickness 厚度
Size 1 规格1				
Size 2 规格2				
Size 3 规格3				
Machine requirements 机器要求				
Speed 速度	_____ strokes/min			
Feeding type 送料方式	<input type="checkbox"/> Mechanical type 机械送料 <input type="checkbox"/> Servo feeding device 伺服送料			
Lubrication 润滑方式	<input type="checkbox"/> Normal type 普通润滑方式 <input type="checkbox"/> Automatic type 润滑系统润滑			
Controlling system 控制系统	Electrical control 电控方式		<input type="checkbox"/> Normal type 普通控制柜 <input type="checkbox"/> PLC	
	Other control 其他控制: _____		<input type="checkbox"/> Length calculate 计长 <input type="checkbox"/> pieces calculate 计数	
Mould material 模具材质	<input type="checkbox"/> Die steel 模具钢 <input type="checkbox"/> high-speed steel 高速钢 <input type="checkbox"/> Alloy steel 合金钢 <input type="checkbox"/> TC53			
Accessory machines 辅助设备				
<input type="checkbox"/> Decoiler 开料架 <input type="checkbox"/> Flattener 压平机 <input type="checkbox"/> Straightening machine 校平机 <input type="checkbox"/> Slitting machine 分网机 <input type="checkbox"/> Cutting machine 剪网机 <input type="checkbox"/> Recoiler 收卷机				
* Whether the accessory machine speed need to equip with expanding machine <input type="checkbox"/> No need 不需要 <input type="checkbox"/> Need 需要 辅助设备的速度是否需要与钢板网机速度相匹配 (Please note that accommodation expense for our technicians who sent to aboard to test the machine will be paid by buyer.) 备注: 如需安装调试, 往返食宿费用由客户支付。				

Signed by the customer 客户签名: _____
 Signed by the seller 卖方签名: _____

我们的展会

Our exhibition

2016 德国杜塞尔多夫线材管材展
 2016 Germany Dusseldorf Wire & Tube exhibiton

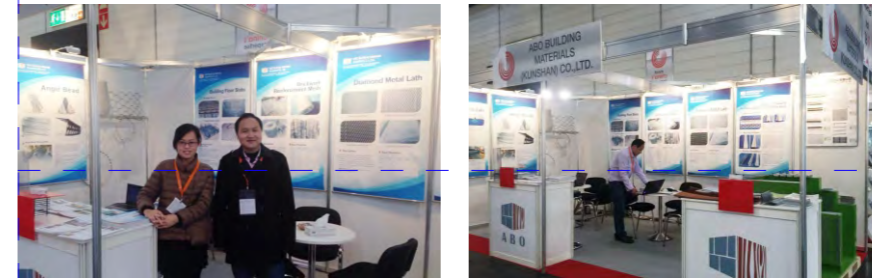

2018 德国展会
 2018 German exhibition



2015美国拉斯维加斯建材展 / 2015 Las Vegas building materials exhibition



2017迪拜展会
 2017 Dubai Big5 exhibition



2016迪拜展会
 2016 Dubai Big5 exhibition



2015迪拜展会
 2015 Dubai Big5 exhibition



委瑞内拉展会
 Venezuela exhibition



广交会 / Canton fair

